

EVALUATION KIT
AVAILABLE



Dual-Output Step-Down and LCD Step-Up Power Supply for PDAs

MAX1878

General Description

The MAX1878 dual power supply contains a step-down and step-up DC-DC converter in a small 12-pin TQFN package for use in PDAs. The step-down DC-DC converter delivers over 500mA to an output as low as 1.25V for logic power. The step-up DC-DC converter delivers over 15mA and an output as high as 28V for a liquid crystal display (LCD). With an input voltage from 2.0V to 5.5V the MAX1878 is intended for use in systems powered by a 2-cell alkaline or 1-cell lithium-ion (Li+) battery.

Fast switching frequency allows the use of small inductors and capacitors, and the low 19 μ A typical quiescent current allows high efficiency when the system is in standby mode. Each output can be independently enabled.

The MAX1878 is available in a small 0.75mm high 4mm x 4mm 12-pin TQFN package and requires no external FETs. The MAX1878 evaluation kit is available to speed designs.

Applications

Personal Digital Assistants (PDA)
Organizers/Translators
MP3 Players
GPS Receivers

Typical Operating Circuit

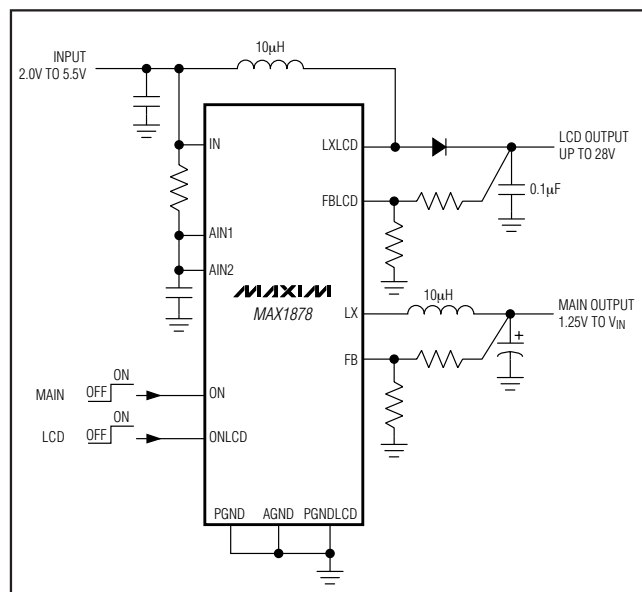

Features

- ◆ Evaluation Kit Available to Speed Designs
- ◆ Two Output Voltages
 - Main Output: 1.25V to V_{IN}
 - LCD Output: Up to 28V
- ◆ 2.0V to 5.5V Input Range
- ◆ Low 19 μ A Quiescent Supply Current
- ◆ 1 μ A Shutdown Supply Current
- ◆ High Switching Frequency for Small External Components
- ◆ Small 0.75mm High 4mm x 4mm 12-Pin TQFN Package

Ordering Information

PART	TEMP RANGE	PIN-PACKAGE	TOP MARK
MAX1878ETC+	-40°C to +85°C	12-TQFN-EP*	AAGC

+ Denotes a lead (Pb)-free/RoHS-compliant package.

*EP = Exposed pad.

Pin Configuration

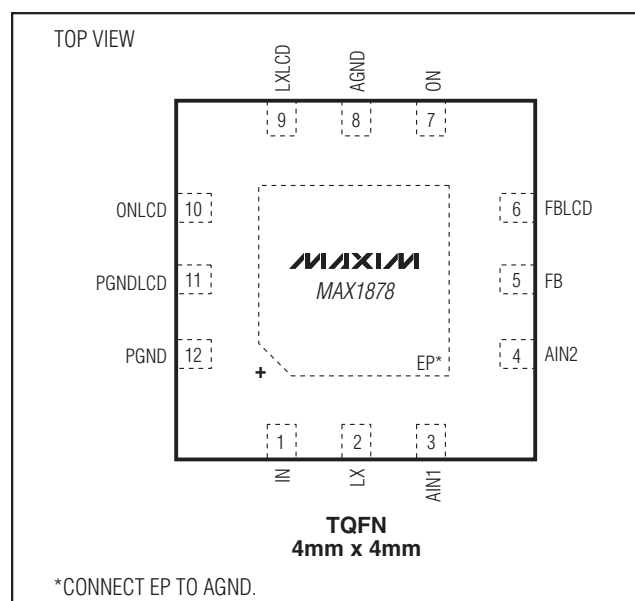

Dual-Output Step-Down and LCD Step-Up Power Supply for PDAs

ABSOLUTE MAXIMUM RATINGS

FB, FBLCD, AIN1, AIN2, ON, ONLCD to AGND	-0.3V to +6V
AIN2 to AIN1	-0.3V to +0.3V
AIN1, AIN2 to IN	-0.3V to +0.3V
IN to PGND	-0.3V to +6V
LX to PGND	-0.3V to ($V_{IN} + 0.3V$)
LXLCD to PGNDLCD	-0.3V to +30V
PGND, PGNDLCD to AGND	-0.3V to +0.3V
LX Current	800mA
LXLCD Current	500mA

Continuous Power Dissipation ($T_A = +70^\circ\text{C}$)	
12-Pin TQFN (derate 24.4mW/ $^\circ\text{C}$ above $+70^\circ\text{C}$)	1.95W
Operating Temperature Range	-40°C to $+85^\circ\text{C}$
Junction Temperature	$+150^\circ\text{C}$
Storage Temperature Range	-65°C to $+150^\circ\text{C}$
Lead Temperature (soldering, 10s)	$+300^\circ\text{C}$
Soldering Temperature (reflow)	$+260^\circ\text{C}$

Stresses beyond those listed under "Absolute Maximum Ratings" may cause permanent damage to the device. These are stress ratings only, and functional operation of the device at these or any other conditions beyond those indicated in the operational sections of the specifications is not implied. Exposure to absolute maximum rating conditions for extended periods may affect device reliability.

PACKAGE THERMAL CHARACTERISTICS (Note 1)

TQFN

Junction-to-Ambient Thermal Resistance (θ_{JA})	$41^\circ\text{C}/\text{W}$
Junction-to-Case Thermal Resistance (θ_{JC})	$6^\circ\text{C}/\text{W}$

Note 1: Package thermal resistances were obtained using the method described in JEDEC specification JESD51-7, using a four-layer board. For detailed information on package thermal considerations, refer to www.maxim-ic.com/thermal-tutorial.

ELECTRICAL CHARACTERISTICS

($V_{IN} = V_{AIN} = 2.5V$, circuit of Figure 1, $T_A = 0^\circ\text{C}$ to $+85^\circ\text{C}$, unless otherwise noted. Typical values are at $T_A = +25^\circ\text{C}$.)

PARAMETER	SYMBOL	CONDITIONS	MIN	TYP	MAX	UNITS	
GENERAL							
Input Voltage Range	V_{IN}, V_{AIN}		2.0		5.5	V	
Undervoltage Lockout Threshold	V_{UVLO}	V_{IN} rising		1.92	2.0	V	
		V_{IN} falling	1.7	1.82			
Undervoltage Lockout Hysteresis				100		mV	
Quiescent Current	$I_{AIN1} + I_{AIN2}$	$V_{FB} = V_{FBLCD} = 1.30V, V_{ONLCD} = 0V$, step-down converter only		19	30	μA	
		$V_{FB} = V_{FBLCD} = 1.30V$		24	38		
Shutdown Quiescent Current		$V_{ON} = V_{ONLCD} = 0V$		0	1	μA	
MAIN OUTPUT (Step-Down Converter)							
Output Voltage Adjustment Range	V_{MAIN}		1.25		V_{IN}	V	
FB Regulation Voltage	V_{FB}	$V_{IN} = V_{AIN} = 2V$	$T_A = +25^\circ\text{C}$ to $+85^\circ\text{C}$	1.225	1.250	1.275	V
			$T_A = 0^\circ\text{C}$ to $+85^\circ\text{C}$	1.220		1.280	
FB Input Bias Current	I_{FB}	$V_{IN} = V_{AIN} = 2V$		10	50	nA	
Main Output Current (Note 2)	I_{MAIN}	$V_{MAIN} = 1.8V$	$V_{IN} = V_{AIN} = 2.5V$	250	500	mA	
			$V_{IN} = V_{AIN} = 2.0V$	200	350		
Line Regulation		$I_{LOAD} = 150\text{mA}, V_{IN} = V_{AIN} = 2V$ to $3V$, $FB = GND$		1		%	
Load Regulation		$V_{IN} = V_{AIN} = 2.5V, I_{LOAD} = 10\text{mA}$ to 150mA		1		%	
Dropout Voltage		$V_{IN} = V_{AIN} = 2V, I_{LOAD} = 150\text{mA}$, $V_{FB} = 0.8V$			150	mV	
		$V_{IN} = V_{AIN} = 3V, I_{LOAD} = 150\text{mA}$, $V_{FB} = 0.8V$			100		

Dual-Output Step-Down and LCD Step-Up Power Supply for PDAs

MAX1878

ELECTRICAL CHARACTERISTICS (continued)

($V_{IN} = V_{AIN} = 2.5V$, circuit of Figure 1, $T_A = 0^\circ C$ to $+85^\circ C$, unless otherwise noted. Typical values are at $T_A = +25^\circ C$.)

PARAMETER	SYMBOL	CONDITIONS	MIN	TYP	MAX	UNITS	
LX Max Duty Cycle		$V_{FB} = 0.8V$	100			%	
LX Leakage Current		$V_{ON} = 0V, V_{IN} = 5.5V$		0.1	5	μA	
LX P-Channel On-Resistance		$V_{IN} = V_{AIN} = 2V, I_{LX} = 300mA$		0.55	0.95	Ω	
		$V_{IN} = V_{AIN} = 3V, I_{LX} = 300mA$		0.42	0.65		
LX N-Channel On-Resistance		$V_{IN} = V_{AIN} = 2V, I_{LX} = 300mA$		0.62	0.93	Ω	
		$V_{IN} = V_{AIN} = 3V, I_{LX} = 300mA$		0.46	0.65		
LX Current Limit			330	550	800	mA	
Idle Mode Threshold			70	135	220	mA	
LX Minimum On-Time	t_{LXON}		240	440	740	ns	
LX Minimum Off-Time	t_{LXOFF}		200	390	670	ns	
ON Input Low Voltage		$2V < V_{IN} < 5.5V$			0.4	V	
ON Input High Voltage		$2V < V_{IN} < 5.5V$	1.3			V	
ON Input Leakage Current			-1		1	μA	
LCD OUTPUT (Step-Up Converter)							
LCD Output Voltage Adjust Range	V_{LCD}		$V_{IN} + 1V$		28	V	
FBLCD Regulation Voltage	V_{FBLCD}	$V_{IN} = V_{AIN} = 2V$	$T_A = +25^\circ C$ to $+85^\circ C$	1.225	1.250	1.275	V
			$T_A = 0^\circ C$ to $+85^\circ C$	1.220		1.280	
LXLCD On-Resistance		$V_{AIN} = V_{IN} = 2V, I_{LXLCD} = 150mA$		2.8	5.0	Ω	
		$V_{AIN} = V_{IN} = 3V, I_{LXLCD} = 150mA$		1.7	3.0		
LXLCD Current Limit			140	280	440	mA	
LXLCD Leakage Current		$V_{LXLCD} = 28V$		0	1	μA	
LCD Output Current (Note 3)	I_{LCD}	$V_{AIN} = V_{IN} = 2.5V, V_{LCD} = 18V$	1.5	7.6		mA	
		$V_{AIN} = V_{IN} = 2V, V_{LCD} = 18V$	1.4	6.6			
FBLCD Input Bias Current	I_{FBLCD}	$V_{AIN} = V_{IN} = 2V$		10	50	nA	
LCD Line Regulation		$V_{AIN} = V_{IN} = 2V$ to $3V, I_{LOAD} = 5mA,$ $V_{LXLCD} = 18V$		1		%	
LCD Load Regulation		$V_{AIN} = V_{IN} = 2.5V, I_{LOAD} = 1mA$ to $5mA,$ $V_{LXLCD} = 18V$		1.3		%	
LXLCD Maximum On-Time	$t_{LXLCDON}$		5.1	9.8	17	μs	
LXLCD Minimum Off-Time	$t_{LXLCDOFF}$		0.5	1.0	1.7	μs	
		$V_{FBLCD} < 0.9V$ (soft-start)	1.3	2.6	4.4		
ONLCD Input Low Voltage		$2V < V_{AIN} = V_{IN} < 5.5V$			0.4	V	
ONLCD Input High Voltage		$2V < V_{AIN} = V_{IN} < 5.5V$	1.3			V	
ONLCD Input Leakage Current			-1		1	μA	

Dual-Output Step-Down and LCD Step-Up Power Supply for PDAs

ELECTRICAL CHARACTERISTICS

($V_{IN} = V_{AIN} = 2.5V$, circuit of Figure 1, $T_A = -40^{\circ}C$ to $+85^{\circ}C$, unless otherwise noted.) (Note 4)

PARAMETER	SYMBOL	CONDITIONS	MIN	MAX	UNITS
GENERAL					
Quiescent Current from AIN	I_{AIN}	$V_{FB} = V_{FBLCD} = 1.30V$		38	μA
MAIN OUTPUT (Step-Down Converter)					
FB Regulation Voltage	V_{FB}	$V_{AIN} = V_{IN} = 2V$	1.212	1.288	V
LX Current Limit			310	820	mA
LX Minimum On-Time	t_{LXON}		240	740	ns
LX Minimum Off-Time	t_{LXOFF}		200	670	ns
LCD OUTPUT (Step-Up Converter)					
LXLCD Current Limit			130	450	mA
LXLCD Maximum On-Time	$t_{LXLCDON}$		5.1	17	μs
LXLCD Minimum Off-Time	$t_{LXLCDOFF}$		0.5	1.7	μs
		$V_{FBLCD} < 0.9V$	1.3	4.5	
FBLCD Regulation Voltage	V_{FBLCD}	$V_{AIN} = V_{IN} = 2V$	1.212	1.288	V

Note 2: Main output current is guaranteed by LX current limit, LX on resistance, and LX minimum off-time.

Note 3: LCD output current is guaranteed by LXLCD current limit, LXLCD on-resistance, and LXLCD minimum off-time, starting into a resistive load.

Note 4: Specifications to $T_A = -40^{\circ}C$ are guaranteed by design and not production tested.

Dual-Output Step-Down and LCD Step-Up Power Supply for PDAs

Typical Operating Characteristics

($V_{IN} = V_{AIN} = 2.5V$, circuit of Figure 1, $T_A = +25^\circ C$, unless otherwise noted.)

MAX1878

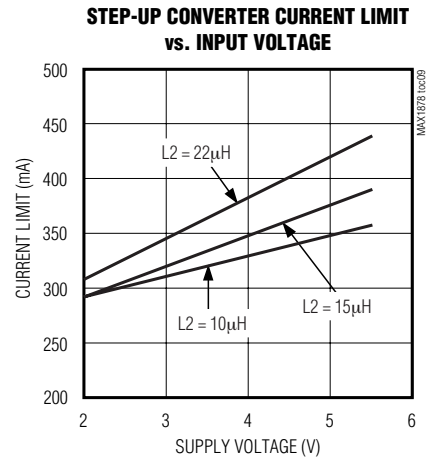
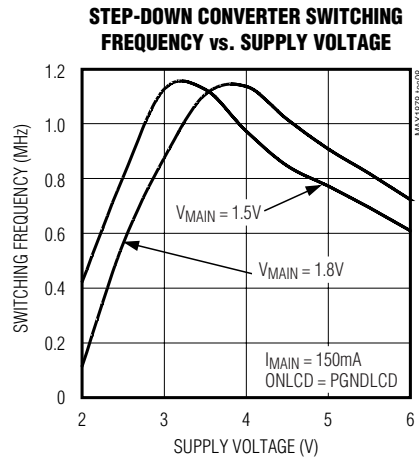
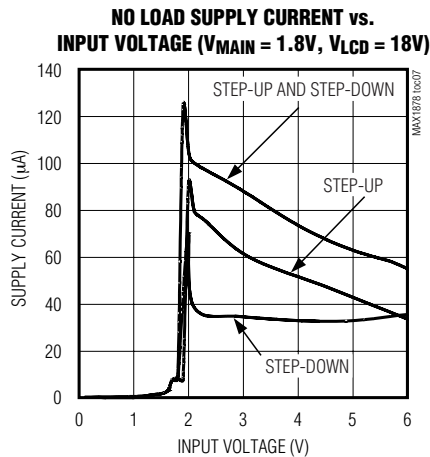
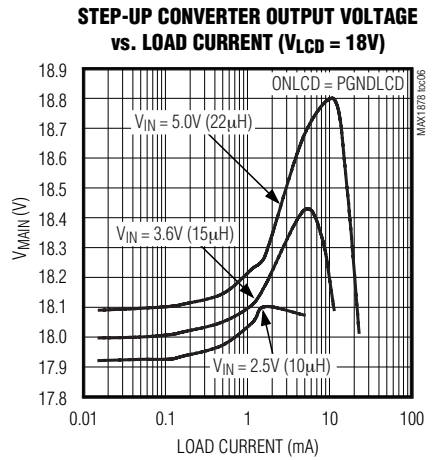
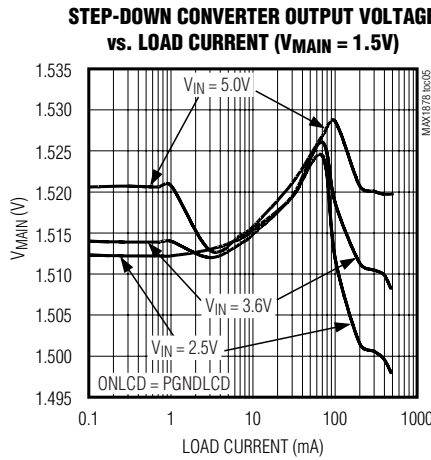
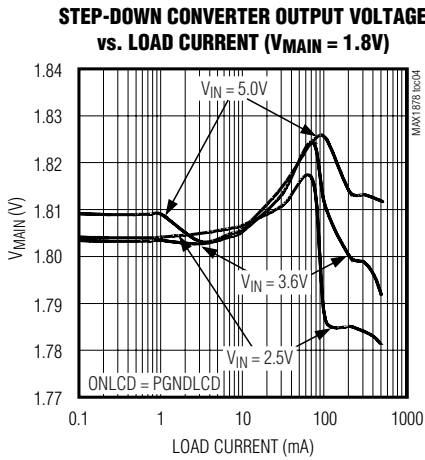
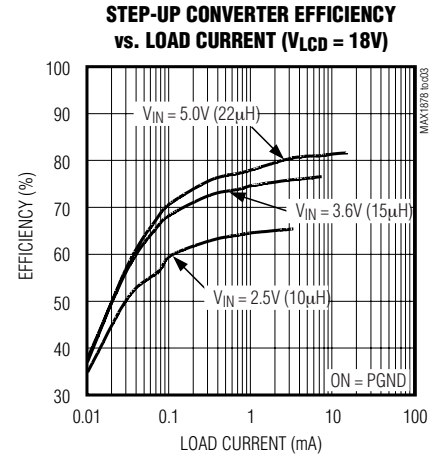
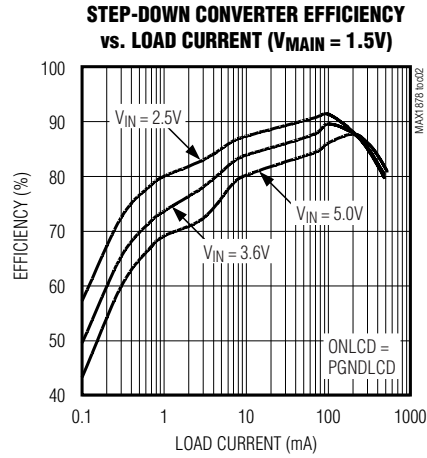
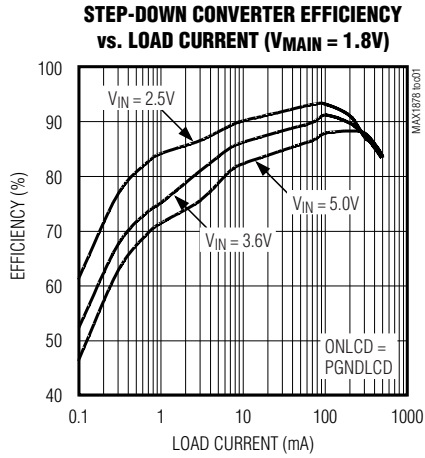

Dual-Output Step-Down and LCD Step-Up Power Supply for PDAs

Typical Operating Characteristics (continued)

($V_{IN} = V_{AIN} = 2.5V$, circuit of Figure 1, $T_A = +25^\circ C$, unless otherwise noted.)

STEP-DOWN LIGHT-LOAD SWITCHING WAVEFORMS

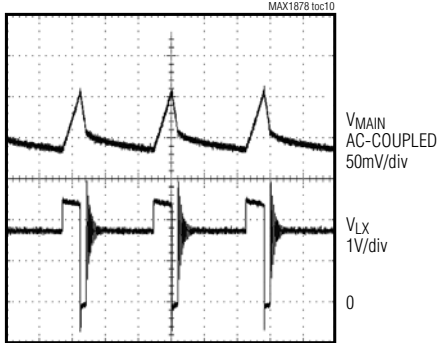

$I_{MAIN} = 20mA$, $V_{MAIN} = +1.8V$, $V_{IN} = +2.5V$, ONLCD = PGNDLCD

STEP-DOWN HEAVY-LOAD SWITCHING WAVEFORMS

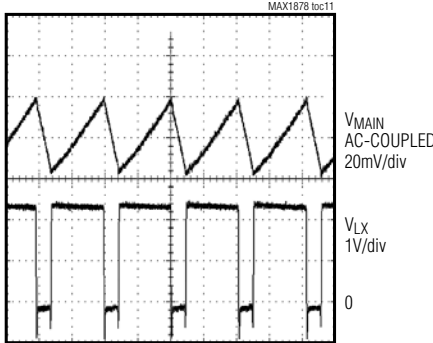

$I_{MAIN} = 250mA$, $V_{MAIN} = +1.8V$, $V_{IN} = +2.5V$, ONLCD = PGNDLCD

STEP-UP LIGHT-LOAD SWITCHING WAVEFORMS

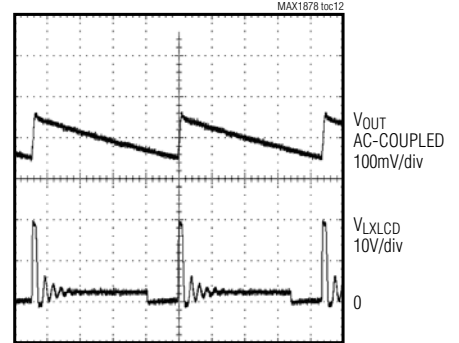

$I_{LCD} = 2mA$, $V_{LCD} = +18V$, $V_{IN} = +2.5V$, ON = PGND

STEP-UP HEAVY-LOAD SWITCHING WAVEFORMS

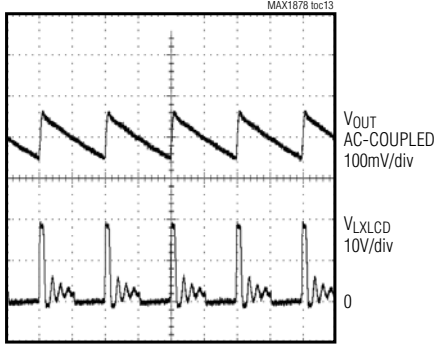

$I_{LCD} = 4.5mA$, $V_{LCD} = +18V$, $V_{IN} = +2.5V$, ON = PGND

STEP-DOWN LOAD TRANSIENT RESPONSE

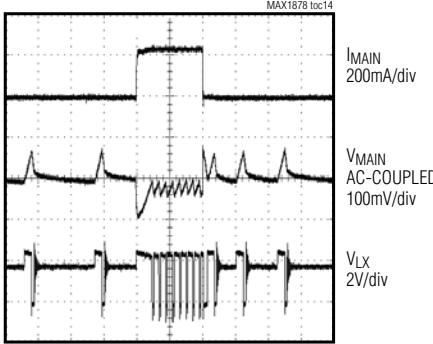

$I_{MAIN} = 10mA$ to $250mA$, $V_{MAIN} = +1.8V$, $V_{IN} = +2.5V$, ONLCD = PGNDLCD

STEP-UP LOAD TRANSIENT RESPONSE

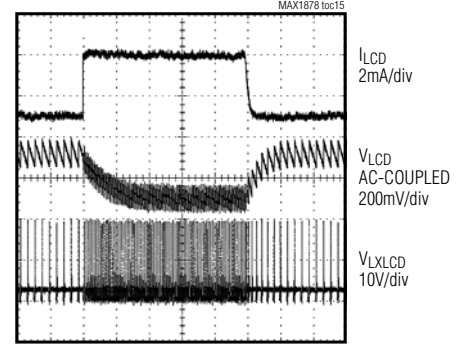

$I_{LCD} = 1mA$ to $4mA$, $V_{LCD} = +18V$, $V_{IN} = +2.5V$, ON = PGND

LINE TRANSIENT RESPONSE

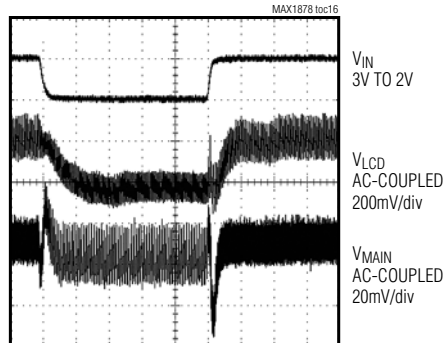

$V_{MAIN} = +1.8V$, $I_{MAIN} = 150mA$, $V_{LCD} = 18.0V$, $I_{LCD} = 2.5mA$

SOFT-START AND SHUTDOWN RESPONSE

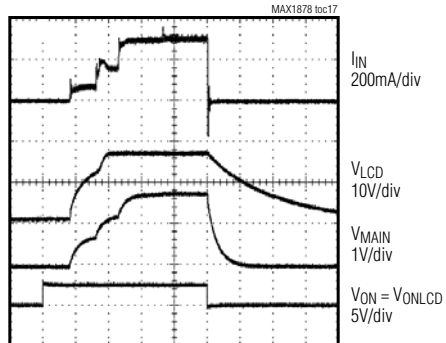

$R_{MAIN} = 5.1\Omega$, $R_{LCD} = 9.09k\Omega$

Dual-Output Step-Down and LCD Step-Up Power Supply for PDAs

Pin Description

MAX1878

PIN	NAME	FUNCTION
1	IN	Step-Down Converter Power Input. Connect IN to the step-down converter power source. Bypass IN to PGND with a 10 μ F or greater low-ESR capacitor.
2	LX	Step-Down Converter Switching Node. Connect LX to the step-down converter output LC filter. LX swings between IN and PGND.
3	AIN1	Analog Input Power 1. AIN1 supplies power to the MAX1878 internal circuitry. Connect AIN1 to the 2.0V to 5.5V input power source. Bypass AIN1 to AGND with a 1 μ F or greater low-ESR capacitor.
4	AIN2	Analog Input Power 2. Connect AIN1 and AIN2 together as close to the MAX1878 as possible.
5	FB	Step-Down Converter Feedback Input. Connect a resistive voltage-divider from the step-down converter output voltage to FB. The regulation threshold is 1.25V at FB.
6	FBLCD	LCD Step-Up Converter Feedback Input. Connect a resistive voltage-divider from the step-up converter output voltage to FBLCD. The regulation threshold is 1.25V at FBLCD.
7	ON	Step-Down Converter On/Off Input. Drive ON high to turn on the step-down converter. Drive ON low to turn off the converter. For automatic startup, connect ON to AIN1.
8	AGND	Analog (Low-Noise) Ground. The exposed pad and the corner tabs on the TQFN package are internally connected to analog ground. See the <i>PC Board Layout and Grounding</i> section.
9	LXLCD	LCD Step-Up Converter Switching Node. Connect LXLCD to the step-up converter inductor and rectifier.
10	ONLCD	LCD Step-Up Converter On/Off Input. Drive ONLCD high to turn on the step-up converter. Drive ONLCD low to turn off the converter. For automatic startup, connect ONLCD to AIN1.
11	PGNDLCD	LCD Step-Up Converter Power Ground. PGNDLCD is the source of the step-up converter's internal N-channel MOSFET switch. Connect PGNDLCD to PGND as close to the MAX1878 as possible.
12	PGND	Power Ground. PGND is the source of the step-down converter's internal N-channel MOSFET synchronous rectifier. Connect PGND to PGNDLCD as close to the MAX1878 as possible.
—	EP	Exposed Pad. Internally connected to AGND. Connect to a large analog ground (AGND) plane to maximize thermal performance. Not intended to use as an electrical connection point.

Detailed Description

The MAX1878 step-down and step-up DC-DC converter operates from a 2.0V to 5.5V supply. Consuming only 19 μ A of quiescent supply current, the main step-down converter delivers over 500mA to an output as low as 1.25V and the LCD step-up converter delivers over 15mA and an output as high as 28V. The MAX1878 uses a unique proprietary current-limited control scheme that provides excellent performance and high efficiency.

Step-Down Converter Control Scheme

The MAX1878 step-down converter uses a proprietary, current-limited control scheme to ensure high efficiency, fast transient response, and physically small external components. This control scheme is simple: when the output voltage is out of regulation, the error comparator

begins a switching cycle by turning on the high-side switch. This switch remains on until the minimum on-time of 440ns expires and the output voltage regulates or the current-limit threshold is exceeded. Once off, the high-side switch remains off until the minimum off-time of 390ns expires and the output voltage falls out of regulation. During this period, the low-side synchronous rectifier turns on and remains on until either the high-side switch turns on again or the inductor current approaches zero. The internal synchronous rectifier eliminates the need for an external Schottky diode.

This control scheme allows the MAX1878 step-down converter to provide excellent performance throughout the entire load-current range. When delivering light loads, the high-side switch turns off after the minimum on-time and after the inductor current reaches the 135mA ideal mode threshold to reduce peak inductor

Dual-Output Step-Down and LCD Step-Up Power Supply for PDAs

current, resulting in increased efficiency and reduced output voltage ripple. When delivering medium and higher output currents, the MAX1878 extends either the on-time or the off-time, as necessary to maintain regulation, resulting in nearly constant frequency operation with high efficiency and low output voltage ripple.

Step-Up Converter Control Scheme

The MAX1878 step-up converter features a minimum off-time, current-limited control scheme. The duty cycle is governed by a pair of one-shots that set a minimum off-time and a maximum on-time. The switching frequency can be up to 500kHz and depends upon the load and input voltage. The peak current limit of the internal N-channel MOSFET is 280mA.

On/Off Control

Pulling ON low places the MAX1878 step-down converter in shutdown mode and reduces step-down converter supply current to less than 1 μ A. In shutdown, the internal switching MOSFETs and synchronous rectifier turn off and LX goes high impedance.

Pulling ONLCD low places the MAX1878 step-up converter in shutdown mode and reduces step-up converter supply current to less than 1 μ A. In shutdown, LXLCD

enters a high-impedance state and the output remains connected to the input through the inductor and rectifier holding the output voltage to a diode drop below V_{IN} . The LCD output capacitance and load determine the rate at which V_{LCD} decays. Connect ON and ONLCD to IN for normal operation.

Soft-Start

The MAX1878 internal soft-start circuitry limits current drawn at startup, reducing transients on the input source. Soft-start is particularly useful for higher impedance input sources, such as lithium ion and alkaline cells. Step-down converter soft-start is implemented with current limit. At startup the step-down converter current limit is set to 25% of its full current limit. The current limit is increased by 25% every 256 switching cycles until full current limit is reached. Step-up converter soft-start is implemented with LXLCD minimum off-time. At startup the LXLCD minimum off-time is 2.6 μ s allowing the LCD output voltage to build up gradually. When the output reaches approximately 80% of its final output voltage the LXLCD minimum off-time is decreased to its final value of 1 μ s. See Soft-Start and Shutdown Response in the *Typical Operating Characteristics* section.

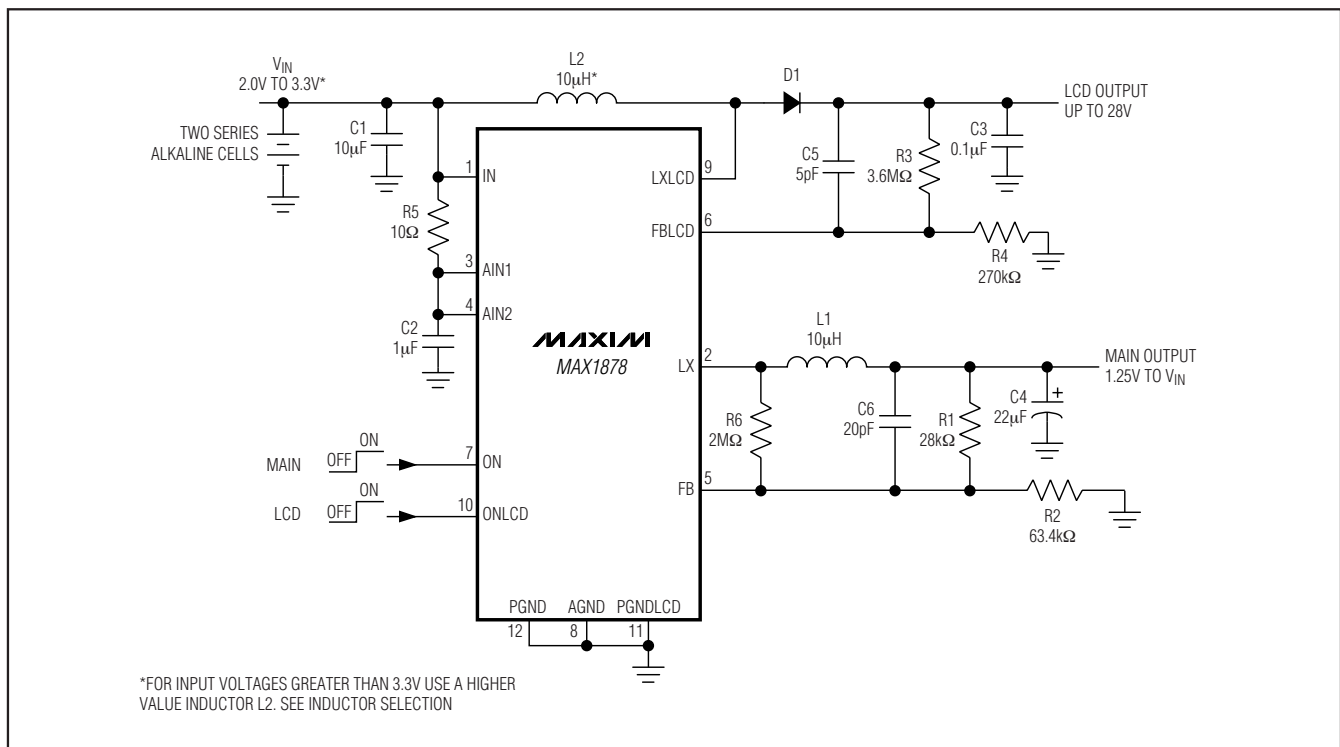

Figure 1. MAX1878 Standard Application Circuit

Dual-Output Step-Down and LCD Step-Up Power Supply for PDAs

Design Procedure

Setting the Output Voltage

Set the MAX1878 step-down converter output voltage by connecting a resistive voltage-divider from V_{MAIN} to FB (Figure 1). Select an R_2 from $30k\Omega$ to $300k\Omega$. Calculate R_1 with the following equation:

$$R_1 = \frac{R_2 \times R_6 (V_{MAIN} - V_{FB})}{V_{FB} (R_6 + R_2) - V_{MAIN} \times R_2}$$

where $V_{FB} = 1.25V$, $R_6 = 2M\Omega$ and V_{MAIN} may range from $1.25V$ to V_{IN} .

Set the MAX1878 step-up converter output voltage by connecting a resistive voltage-divider from V_{LCD} to

FBLCD (Figure 1). Select an R_4 from $30k\Omega$ to $300k\Omega$. Calculate R_3 with the following equation:

$$R_3 = R_4 \left(\frac{V_{LCD}}{V_{FBLCD}} - 1 \right)$$

where $V_{FBLCD} = 1.25V$ and V_{LCD} may range from $(V_{IN} + 1V)$ to $28V$.

The FB and FBLCD input bias currents are a maximum of $50nA$. These small bias currents allow for large-value feedback resistors that improve light-load efficiency. For less than 1% output voltage error due to bias current, feedback resistors should be chosen such that the current through R_2 is 100 times greater than I_{FB} and the current through R_4 is 100 times greater than I_{FBLCD} .

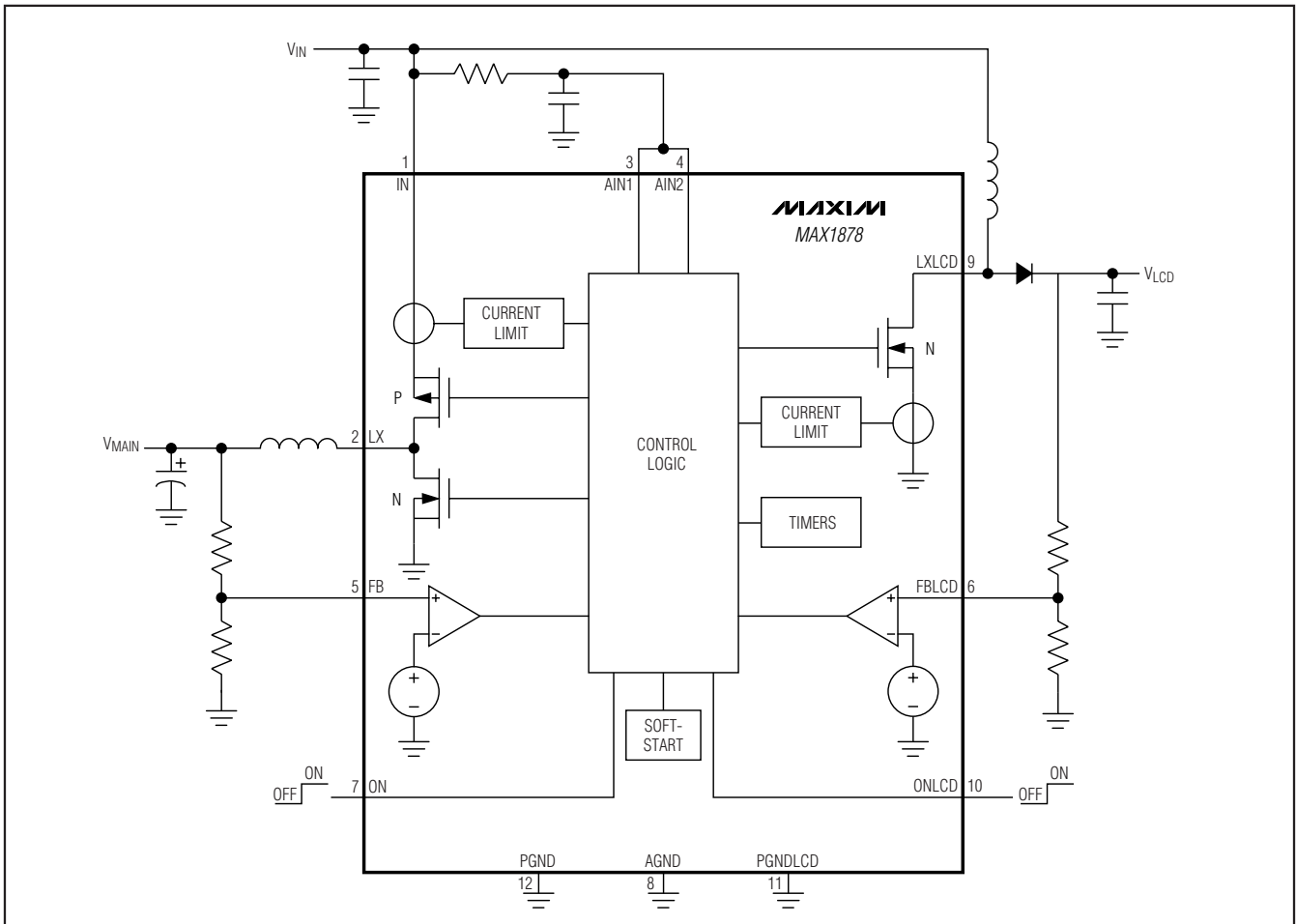

Figure 2. Simplified Functional Diagram

Dual-Output Step-Down and LCD Step-Up Power Supply for PDAs

Inductor Selection

The MAX1878 is optimized to use a 10 μ H inductor over the entire operating range. Smaller inductance values typically offer smaller physical size for a given series resistance or saturation current. Circuits using larger inductance values may startup at lower input voltages and exhibit less ripple, but also provide reduced output power. This occurs when the inductance is sufficiently large to prevent the maximum current limit from being reached before the maximum on-time expires. The inductor's saturation current rating should be greater than the peak switching current. However, it is generally acceptable to bias the inductor into saturation by as much as 20%, although this will slightly reduce efficiency. Choose a low DC-resistance inductor to improve efficiency. For the above reasons choose the step-up converter inductor in the range of 10 μ H to 33 μ H depending on the input voltage (4 μ H per volt of V_{IN}).

Step-Up Converter Diode Selection

The high maximum switching frequency of 500kHz requires a high-speed rectifier such as the 1N4148. To maintain high efficiency, the average current rating of the diode should be greater than the peak switching current. Choose a reverse breakdown voltage greater than the output voltage. A Schottky diode is not recommended as the lower forward voltage does little to improve efficiency whereas the higher reverse leakage current decreases efficiency.

Input Bypass Capacitors

Bypass V_{IN} with a 10 μ F low-ESR surface-mount ceramic capacitor to PGND and PGNDLCD as close to the IC as possible. This input bypass capacitor reduces peak currents and noise at the input voltage source. Connect AIN1 and AIN2 together and bypass with a low-ESR 1 μ F surface-mount ceramic capacitor to AGND. A low resistance (10 Ω) from IN to AIN1 and AIN2 creates a lowpass RC filter and provides low-noise analog input power to the MAX1878.

Output Filter Capacitors

The MAX1878 is a voltage mode converter and requires ripple at FB and FBLCD for stable regulation. For most applications, bypass V_{LCD} with a 0.1 μ F small ceramic surface-mount capacitor to PGNDLCD. For small

ceramic capacitors, the output ripple voltage is dominated by the capacitance value. If tantalum or electrolytic capacitors are used, the higher ESR increases the output ripple voltage. Decreasing the ESR reduces the output ripple voltage and the peak-to-peak transient voltage. Surface-mount capacitors are generally preferred because they lack the inductance and resistance of their through-hole equivalents. Bypass V_{MAIN} with a 10 μ F to 47 μ F tantalum capacitor to PGND. Choose a capacitor with 200m Ω to 300m Ω ESR to provide stable switching while minimizing output ripple. A 22 μ F filter capacitor works well for most applications.

Ripple Regulation

For proper switching control the ripple at FB and FBLCD must be greater than 25mV. Use R6 and C6 as shown in Figure 1 to inject ripple into FB. To insure sufficient ripple on FBLCD, connect C5 as shown in Figure 1.

PC Board Layout and Grounding

High switching frequencies make PC board layout a very important part of design. Good design minimizes excessive EMI on the feedback paths and voltage gradients in the ground plane, both of which can result in instability or regulation errors. Connect the inductors, input filter capacitors, and output filter capacitors as close to the device as possible, and keep their traces short, direct, and wide. The external voltage-feedback networks should be very close to the feedback pins, within 0.2 inches (5mm). Keep noisy traces, such as LX and XLCD, away from the voltage feedback networks; also keep them separate, using grounded copper.

The exposed backside pad and corner tabs of the TQFN package are internally connected to analog ground. For heat dissipation, connect the exposed backside pad to a large analog ground plane, preferably on a surface of the board that receives good airflow. Connect all power grounds and all analog grounds to separate ground planes in a star ground configuration. Connect the analog ground plane and the power ground plane together at a single point. The MAX1878 evaluation kit data sheet includes a proper PC board layout and routing scheme.

Dual-Output Step-Down and LCD Step-Up Power Supply for PDAs

Chip Information

EXPOSED PAD CONNECTED TO AGND
PROCESS: BiCMOS

Package Information

For the latest package outline information and land patterns (footprints), go to www.maxim-ic.com/packages. Note that a "+", "#", or "-" in the package code indicates RoHS status only. Package drawings may show a different suffix character, but the drawing pertains to the package regardless of RoHS status.

PACKAGE TYPE	PACKAGE CODE	OUTLINE NO.	LAND PATTERN NO.
12 TQFN	T1244+4	21-0139	90-0068

MAX1878

Dual-Output Step-Down and LCD Step-Up Power Supply for PDAs

Revision History

REVISION NUMBER	REVISION DATE	DESCRIPTION	PAGES CHANGED
2	5/11	Replaced QFN package with TQFN package and added exposed pad to <i>Pin Description</i> section	1, 7

Maxim cannot assume responsibility for use of any circuitry other than circuitry entirely embodied in a Maxim product. No circuit patent licenses are implied. Maxim reserves the right to change the circuitry and specifications without notice at any time.

12 **Maxim Integrated Products, 120 San Gabriel Drive, Sunnyvale, CA 94086 408-737-7600**

Mouser Electronics

Authorized Distributor

Click to View Pricing, Inventory, Delivery & Lifecycle Information:

[Analog Devices Inc.:](#)

[MAX1878ETC+](#) [MAX1878ETC+T](#)